

Technical sheet :

# ***KLEOS HM 500 D25***

---



 **MANITOU**  
HANDLING YOUR WORLD

Technical characteristics			Metric
1.1	Manufacturer		Manitou
1.2	Model Name		HM 500 D25
1.3	Power source		Manual
1.4	Operator type		Pedestrian
1.5	Max. capacity	Q	500 kg
1.6	Load center of gravity	c	250 mm
Weight			
2.1	Overall weight without tools		190 kg
Wheels			
3.1	Tires type		Nylon
3.2	Dimensions of front wheels		2x (75x65)
3.3	Dimensions of rear wheels		2x (150x50)
Dimensions			
4.2	Mast lowered height	h1	1950 mm
4.5	Mast extended height	h4	2480 mm
4.19	Overall length	l1	1300 mm
4.20	Length to face of forks	l2	575 mm
4.21	Overall width	b1	710 mm
4.25	Fork spread	b5	519 mm
4.32	Ground clearance at centre of wheelbase	m2	35 mm
Performances			
5.2	Lifting speed (laden / unladen)		0.10 m/s / 0.10 m/s
5.3	Lowering speed (laden / unladen)		0.10 m/s / 0.10 m/s
5.11	Parking brake		Mecanic

### Kleos HM 500 D25 - Dimensional drawing

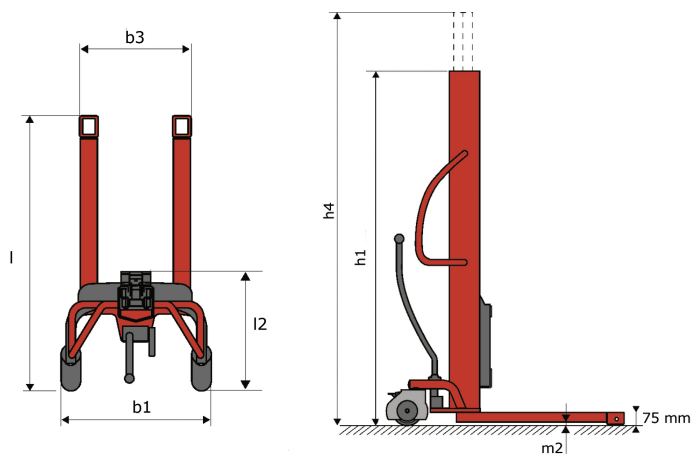

### Tool characteristics

Tool 500 kg	Attachment capacity	Center of gravity of load	A1	A2	B	B1	C	D	E	E1	E2	F	Weight
	kg	mm	mm	mm	mm	mm	mm	mm	mm	mm	mm	mm	kg
EPE 500	500	350	700	715	50	-	252	-	-	-	-	320	30
FA 500	500	350	700	745	-	250	680	45	60	30	-	720	54
FR 500	500	600	1150	1177	560	200	315	85	-	70	-	700	68
FUT 500	300	600	795	650	1057	350	650	245	-	240	631	-	92
PLF 500	500	350	700	727	600	-	280	-	91	-	-	630	50
POT 500	250	600	625	652	50	-	150	-	-	-	-	320	25

# Tools

EPE 500



FA 500



FR 500



FUT 500



PLF 500



POT 500





**Head Office**

B.P. 249 - 430 rue de l'Aubinière

44150 Ancenis Cedex - France

Tel: +33 (0)2 40 09 10 11 - Fax: +33 (0)2 40 09 10 97

[www.manitou.com](http://www.manitou.com)



This publication provides a description of the configuration versions and options for Manitou products, which may differ for equipment. The equipment presented in this brochure may be part of a series, as an option, or it may not be available, depending on the versions. Manitou reserves the right, at any time and without notice, to amend the specifications described and represented. The specifications provided do not bind the manufacturer. For more details, please contact your Manitou agent. This is not a contractually binding document. The presentation of the products is not contractually binding. List of specifications non-exhaustive. The logos as well as the visual identity of the company are owned by Manitou and cannot be used without authorisation. All rights reserved. The photos and diagrams contained in this brochure are only provided for consultation and information purposes.

MANITOU BF SA - Limited company with board of directors - Share capital: 39,668,399 euros - 857 802 508 RCS Nantes