

Ficha técnica :

# **KLEOS HM 500 D25**

---

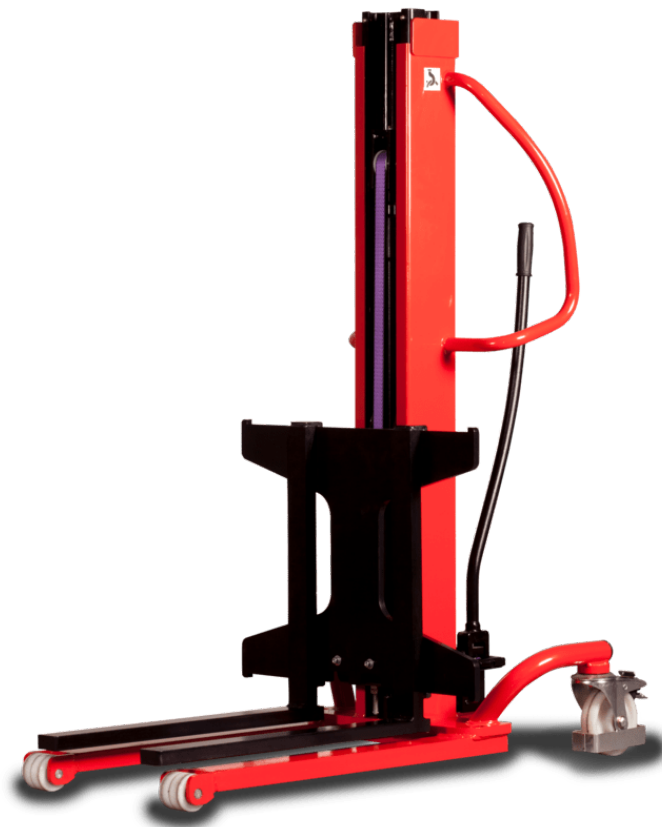

 **MANITOU**  
HANDLING YOUR WORLD

| Características técnicas |  |    | Métrico             |
|--------------------------|--|----|---------------------|
| 1.1                      | Fabricante   |    | Manitou             |
| 1.2                      | Nombre del modelo  |    | Kleos HM 500 D25    |
| 1.3                      | Fuente de alimentación                                     |    | Manual              |
| 1.4                      | Tipo de operario   |    | Acompañante         |
| 1.5                      | Capacidad de elevación máx.                                | Q  | 500 kg              |
| 1.6                      | Centro de gravedad de la carga                             | c  | 250 mm              |
| Weight                   |  |    |                     |
| 2.1                      | Peso de la máquina sin herramientas                        |    | 190 kg              |
| Neumáticos               |  |    |                     |
| 3.1                      | Equipamientos de rueda                                     |    | Nylon               |
| 3.2                      | Medidas ruedas delanteras                                  |    | 2x (75x65)          |
| 3.3                      | Medidas ruedas traseras                                    |    | 2x (150x50)         |
| Dimensions               |  |    |                     |
| 4.2                      | Altura del mástil bajado                                   | h1 | 1950 mm             |
| 4.5                      | Altura del mástil extendido                                | h4 | 2480 mm             |
| 4.19                     | Longitud total   | l1 | 1300 mm             |
| 4.20                     | Longitud hasta cara de las horquillas                      | l2 | 575 mm              |
| 4.21                     | Anchura total  | b1 | 710 mm              |
| 4.25                     | Anchura sobre horquillas                                   | b5 | 519 mm              |
| 4.32                     | Distancia al suelo en el centro de la distancia entre ejes | m2 | 35 mm               |
| Rendimiento              |  |    |                     |
| 5.2                      | Velocidad de elevación (con carga / en vacío)              |    | 0.10 m/s / 0.10 m/s |
| 5.3                      | Velocidad de bajada con carga / en vacío                   |    | 0.10 m/s / 0.10 m/s |
| 5.11                     | Freno de aparcamiento                                      |    | Mecánico            |

### Kleos HM 500 D25 - Diagrama dimensional



### Características de las herramientas

| Herramienta 500 kg | Capacidad del accesorio kg | Centro de gravedad de la carga mm | A1 mm | A2 mm | B mm | B1 mm | C mm | D mm | E mm | E1 mm | E2 mm | F mm | Peso kg |
|--------------------|----------------------------|-----------------------------------|-------|-------|------|-------|------|------|------|-------|-------|------|---------|
| EPE 500            | 500                        | 350                               | 700   | 715   | 50   | -     | 252  | -    | -    | -     | -     | 320  | 30      |
| FA 500             | 500                        | 350                               | 700   | 745   | -    | 250   | 680  | 45   | 60   | 30    | -     | 720  | 54      |
| FR 500             | 500                        | 600                               | 1150  | 1177  | 560  | 200   | 315  | 85   | -    | 70    | -     | 700  | 68      |
| FUT 500            | 300                        | 600                               | 795   | 650   | 1057 | 350   | 650  | 245  | -    | 240   | 631   | -    | 92      |
| PLF 500            | 500                        | 350                               | 700   | 727   | 600  | -     | 280  | -    | 91   | -     | -     | 630  | 50      |
| POT 500            | 250                        | 600                               | 625   | 652   | 50   | -     | 150  | -    | -    | -     | -     | 320  | 25      |

# Tools

EPE 500



FA 500



FR 500



FUT 500



PLF 500



POT 500





**Oficina Central**

B.P. 249 - 430 rue de l'Aubinière

44150 Ancenis Cedex - Francia

Tel.: 00 33 (0)2 40 09 10 11 - Fax: 00 33 (0)2 40 09 10 97

[www.manitou.com](http://www.manitou.com)



Esta publicación describe las versiones y posibilidades de configuración de los productos Manitou que puedan diferir en equipamiento. Los equipamientos presentados en este folleto pueden ser de serie, opcionales o no estar disponibles en algunas versiones. Manitou se reserva el derecho, en cualquier momento y sin previo aviso, de modificar las especificaciones descritas y representadas. Las especificaciones aportadas no comprometen al fabricante. Para más información, póngase en contacto con su concesionario Manitou. Documento no contractual. Presentación de los productos no contractual. Lista de especificaciones no exhaustiva. Los logos y la identidad visual de la empresa son propiedad de Manitou y no pueden ser utilizados sin autorización. Todos los derechos reservados. Las fotos y los esquemas contenidos en este folleto se ofrecen para consulta y a título indicativo solamente.

Manitou BF SA - Sociedad anónima con Consejo de Administración - Capital social: 39 668 399 euros - 857 802 508 RCS Nantes