

Technical sheet :

KLEOS HM 1000 S16



 **MANITOU**
HANDLING YOUR WORLD

Technical characteristics			Metric
1.1	Manufacturer		Manitou
1.2	Model Name		Kleos HM 1000 S16
1.3	Power source		Manual
1.4	Operator type		Pedestrian
1.5	Max. capacity	Q	1000 kg
1.6	Load center of gravity	c	250 mm
Weight			
2.1	Overall weight without tools		220 kg
Wheels			
3.1	Tires type		Nylon
3.2	Dimensions of front wheels		4x (75x65)
3.3	Dimensions of rear wheels		2x (160x40)
Dimensions			
4.2	Mast lowered height	h1	1990 mm
4.5	Mast extended height	h4	1990 mm
4.19	Overall length	l1	1330 mm
4.20	Length to face of forks	l2	570 mm
4.21	Overall width	b1	710 mm
4.25	Forks spread	b5	520 mm
4.32	Ground clearance at centre of wheelbase	m2	25 mm
Performances			
5.2	Lifting speed (laden / unladen)		0.10 m/s / 0.10 m/s
5.3	Lowering speed (laden / unladen)		0.10 m/s / 0.10 m/s
5.11	Parking brake		Mecanic

Kleos HM 1000 S16 - Dimensional drawing

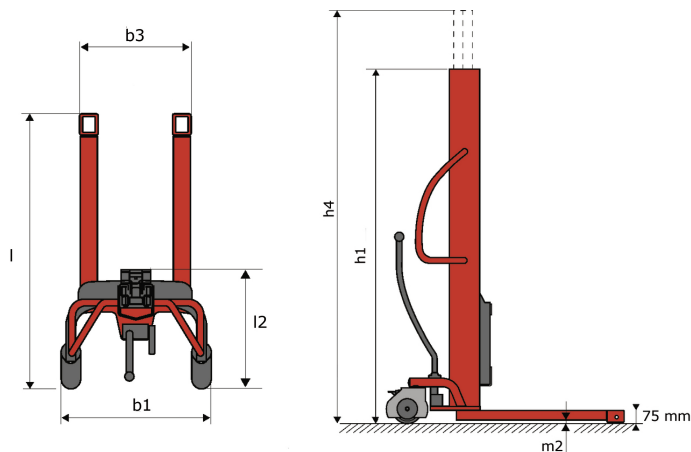

Tool characteristics

Tool 1,000 kg	Attachment capacity	Center of gravity of load	A1	A2	B	B1	C	D	E	E1	E2	F	Weight
	kg	mm	mm	mm	mm	mm	mm	mm	mm	mm	mm	mm	kg
EPE 1000	1000	350	700	730	60	-	245	-	-	-	-	320	38
FA 1000	1000	500	950	1017	-	190	710	45	80	40	-	730	123
FR 1000	1000	600	1150	1182	560	200	320	90	-	70	-	700	82
FUT 1000	300	600	795	600	1057	350	650	245	-	240	631	-	92
PLF 1000	1000	350	700	727	600	-	-	275	-	91	-	630	65
POT 1000	500	600	625	652	50	-	-	145	-	-	-	320	33

Tools

EPE 1000

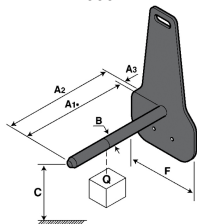

FA 1000

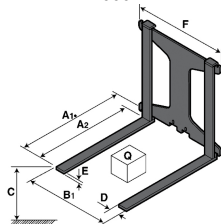

FR 1000

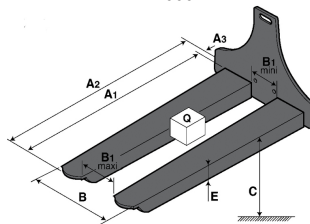

FUT 1000

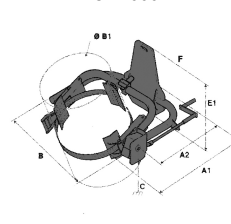

PLF 1000

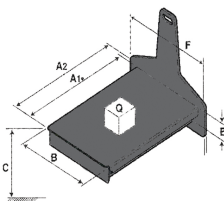

POT 1000

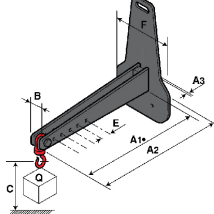



Head Office

B.P. 249 - 430 rue de l'Aubinière
44150 Ancenis Cedex - France

Tel: +33 (0)2 40 09 10 11 - Fax: +33 (0)2 40 09 10 97

www.manitou.com



This publication provides a description of the configuration versions and options for Manitou products, which may differ for equipment. The equipment presented in this brochure may be part of a series, as an option, or it may not be available, depending on the versions. Manitou reserves the right, at any time and without notice, to amend the specifications described and represented. The specifications provided do not bind the manufacturer. For more details, please contact your Manitou agent. This is not a contractually binding document. The presentation of the products is not contractually binding. List of specifications non-exhaustive. The logos as well as the visual identity of the company are owned by Manitou and cannot be used without authorisation. All rights reserved. The photos and diagrams contained in this brochure are only provided for consultation and information purposes.

MANITOU BF SA - Limited company with board of directors - Share capital: 39,668,399 euros - 857 802 508 RCS Nantes