

Technical sheet :

# **MI-X 70 D**

---



 **MANITOU**  
HANDLING YOUR WORLD

Technical characteristics		Metric	
1.1	Manufacturer		Manitou
1.2	Model Name		MI-X 70 D
1.3	Power source		Diesel
1.4	Operator type		Seated
1.5	Max. capacity	Q	7000 kg
1.6	Load center of gravity	c	600 mm
1.8	Load distance, centre of drive axle to fork	x	603 mm
1.9	Wheelbase	y	2300 mm
Weight			
2.1	Service weight		9595 kg
2.2	Weight on front axle (laden) / rear axle (laden)		14830 kg / 1765 kg
2.3	Weight on front axle (Unladen) / rear axle (Unladen)		3910 kg / 5685 kg
Wheels			
3.1	Tires type		Pneumatic
3.2	Dimensions of front wheels		8.25-15-14PR
3.3	Dimensions of rear wheels		8.25-15-14PR
3.5	Number of front wheels / rear wheels		4 / 2
3.5.2	Number of drive wheels		4
3.6	Front wheel gauge	b10	1489 mm
3.7	Rear wheel gauge	b11	1700 mm
Dimensions			
4.8	Seat height/stand height	h7	1350 mm
4.7	Height of overhead guard (cabin)	h6	2430 mm
4.12	Height of towing bar (coupling height)	h10	710 mm
4.19	Overall length	l1	4804 mm
4.20	Length to face of forks	l2	3584 mm
4.21	Overall width	b1	1990 mm
4.21	Overall width - Single wheels	b1	1990 mm
4.22	Forks section / width / length	s / e / l	65 mm x 150 mm x 1220 mm
4.23	Fork carriage ISO 2328 (class/form) A/B		4A
4.24	Fork carriage width	b3	1700 mm
4.31	Ground clearance below mast	m1	190 mm
4.32	Ground clearance at centre of wheelbase	m2	270 mm
4.33	Aisle Width for pallets 1000 x 1200 crossways	Ast	5242 mm
4.34	Aisle width for 800 x 1200 pallet lengthways	Ast	5377 mm
4.36	Internal turning radius (over tyres)	b13	1222 mm
Performances			
5.1	Travel speed (laden / unladen)		26 km/h-29 km/h
5.2	Lifting speed (laden / unladen)		0.41 m/s-0.46 m/s
5.3	Lowering speed (laden / unladen)		0.48 m/s-0.42 m/s
5.5	Drawbar pull (Laden / Unladen)		6800 daN / 2750 daN
5.7	Gradeability (laden)		36 %
5.10	Service brake		Hydraulic
	Transmission type		Torque converter
Engine			
7.1	Engine brand / model / norm		Cummins / QSB3,3 / Stage IIIA
7.2	Engine power (Hp / kW)		101 Hp/74 kW
7.3	Rated speed		2200 rpm
7.4	Number of cylinders / Capacity of cylinders		4 - 3300 cm³
Miscellaneous			
8.2	Working hydraulic pressure for attachments		195 bar
8.3	Oil flow rate for attachments		55 l/min
8.4	Measured/guaranteed mean noise level at the ear of the operator		< 88 dB
8.4	Sound level at the driver's ear according to DIN 12 053		88 dB

### MI-X 70 D - Dimensional drawing

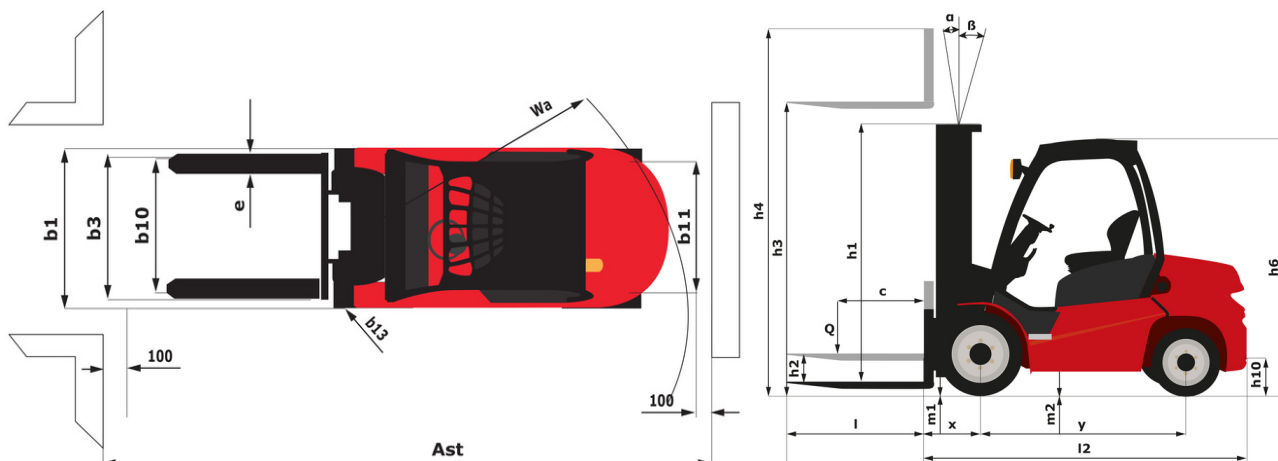

## Characteristics of masts and residual capacities

Full Visibility Duplex (FVD)	FVD 30	FVD 33	FVD 36	FVD 40	FVD 45	FVD 50
α - Mast/fork carriage tilt, forward	°	6	6	6	6	6
β - Mast/fork carriage tilt, backward	°	12	12	12	12	6
h1 - Mast lowered height	mm	2500	2650	2800	3000	3300
h2 - Mast free lift	mm	160	160	160	160	160
h3 - Mast lifting height	mm	3000	3300	3600	4000	4500
h4 - Mast extended height	mm	4167	4467	4767	5167	5667
Residual capacity at max height	kg	7000	7000	7000	7000	7000
Residual capacity with hooked-on side shift at max height	kg	6500	6500	6500	6500	6500
Height at max capacity	mm	3000	3300	3600	4000	4500
Height at max capacity with hooked-on sideshift	mm	3000	3300	3600	4000	4500

Free Lift Duplex (FLD)	FLD 30	FLD 33	FLD 36	FLD 40
α - Mast/fork carriage tilt, forward	°	6	6	6
β - Mast/fork carriage tilt, backward	°	12	12	12
h1 - Mast lowered height	mm	2450	2600	2750
h2 - Mast free lift	mm	1335	2485	1635
h3 - Mast lifting height	mm	3000	3300	3600
h4 - Mast extended height	mm	4115	4415	4715
Residual capacity at max height	kg	7000	7000	7000
Residual capacity with hooked-on side shift at max height	kg	6500	6500	6500
Height at max capacity	mm	3000	3300	3600
Height at max capacity with hooked-on sideshift	mm	3000	3300	3600

Free Lift Triplex (FLT)	FLT 45	FLT 48	FLT 50	FLT 55	FLT 60
α - Mast/fork carriage tilt, forward	°	6	6	6	3
β - Mast/fork carriage tilt, backward	°	6	6	6	6
h1 - Mast lowered height	mm	2725	2825	2875	3075
h2 - Mast free lift	mm	1500	1600	1672	1800
h3 - Mast lifting height	mm	4500	4800	5000	5500
h4 - Mast extended height	mm	5735	6035	6213	6785
Residual capacity at max height	kg	6400	6300	6300	6100
Residual capacity with hooked-on side shift at max height	kg	5900	5800	5800	5600
Height at max capacity	mm	4500	4800	5000	5500
Height at max capacity with hooked-on sideshift	mm	4500	4800	5000	5500



**Head Office**

B.P. 249 - 430 rue de l'Aubinière  
44150 Ancenis Cedex - France

Tel: +33 (0)2 40 09 10 11 - Fax: +33 (0)2 40 09 10 97

[www.manitou.com](http://www.manitou.com)



This publication provides a description of the configuration versions and options for Manitou products, which may differ for equipment. The equipment presented in this brochure may be part of a series, as an option, or it may not be available, depending on the versions. Manitou reserves the right, at any time and without notice, to amend the specifications described and represented. The specifications provided do not bind the manufacturer. For more details, please contact your Manitou agent. This is not a contractually binding document. The presentation of the products is not contractually binding. List of specifications non-exhaustive. The logos as well as the visual identity of the company are owned by Manitou and cannot be used without authorisation. All rights reserved. The photos and diagrams contained in this brochure are only provided for consultation and information purposes.

MANITOU BF SA - Limited company with board of directors - Share capital: 39,668,399 euros - 857 802 508 RCS Nantes