

Technical sheet :

# CT 30



Technical characteristics		Metric	
1.1	Manufacturer		Manitou
1.2	Model Name		CT 30
1.3	Power source		Electrical
1.4	Operator type		Carried
1.5	Max. capacity	Q	3000 kg
1.9	Wheelbase	y	1109 mm
Weight			
2.1	Service weight		1270 kg
2.3	Axle loading unladen (front / rear)		800 kg / 470 kg
Wheels			
3.1	Tires type		Bandage
3.2	Dimensions of front wheels		254 x 100
3.3	Dimensions of rear wheels		250 x 75
3.4	Additional wheels (dimensions)		140 x 40
3.5	Number of front wheels / rear wheels		2 / 2
3.5.2	Drive wheels (front / rear)		1 / 0
3.6	Front wheel gauge	b10	581 mm
3.7	Rear wheel gauge	b11	633 mm
Dimensions			
4.9	Height tiller up max.*	h14	1212 mm
4.12	Height of towing bar (coupling height)	h10	220 mm
4.17	Coupling distance to rear axle	l5	255 mm
4.19	Overall length	l1	1551 mm
4.21	Overall width	b1	800 mm
4.32	Ground clearance at centre of wheelbase	m2	50 mm
4.35	Turning radius	Wa	1332 mm
Performances			
5.1	Travel speed (laden / unladen)		9 km/h / 12 km/h
5.8	Max Gradeability (laden / unladen)		6 % / 13 %
5.10	Service brake		Electro magnetic
5.11	Parking brake		Butterfly switch release
Engine			
6.1	Drive motor rating S2 60 min		2 kW
6.3	Battery according to DIN 43531/35/36 A, B, C		Traction
6.4	Battery voltage / capacity		24 V / 375 Ah
6.5	Battery weight (+/- 5%)		370 kg
Miscellaneous			
8.1	Type of drive control		Mosfet AC speed controller
8.4	Sound level at the driver's ear according to DIN 12 053		66 dB

### CT 30 - Dimensional drawing

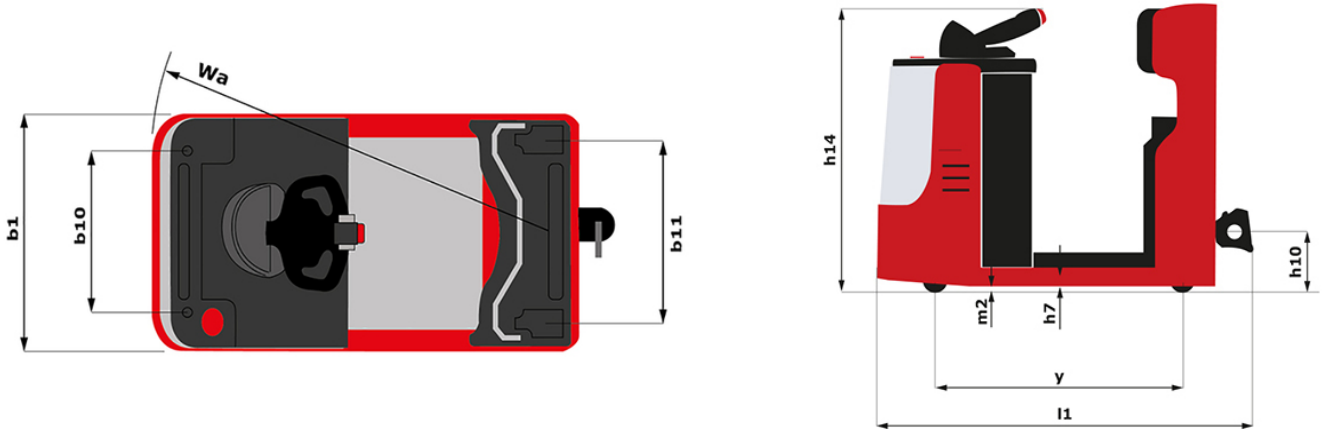



**Head Office**

B.P. 249 - 430 rue de l'Aubinière

44150 Ancenis Cedex - France

Tel: +33 (0)2 40 09 10 11 - Fax: +33 (0)2 40 09 10 97

[www.manitou.com](http://www.manitou.com)



This publication provides a description of the configuration versions and options for Manitou products, which may differ for equipment. The equipment presented in this brochure may be part of a series, as an option, or it may not be available, depending on the versions. Manitou reserves the right, at any time and without notice, to amend the specifications described and represented. The specifications provided do not bind the manufacturer. For more details, please contact your Manitou agent. This is not a contractually binding document. The presentation of the products is not contractually binding. List of specifications non-exhaustive. The logos as well as the visual identity of the company are owned by Manitou and cannot be used without authorisation. All rights reserved. The photos and diagrams contained in this brochure are only provided for consultation and information purposes.

MANITOU BF SA - Limited company with board of directors - Share capital: 39,668,399 euros - 857 802 508 RCS Nantes