

Technical sheet :

MXT 840 P



 **MANITOU**
HANDLING YOUR WORLD

Capacities		Metric
Max. capacity	Q	4000 kg
Max. lifting height		7.60 m
Maximum outreach		4.23 m
Weight and dimensions		
Overall length to carriage	l11	4.67 m
Length to face of forks	l2	4.85 m
Overall width	b1	2.38 m
Overall height	h17	2.59 m
Wheelbase	y	2.58 m
Ground clearance	m4	380 mm
Overall cab width	b4	0.85 m
Tilt-up angle	a4	12 °
Tilt-down angle	a5	134 °
External turning radius (over tyres)	Wa1	3.90 m
Unladen weight (with forks)		8260 kg
Overall weight		8140 kg
Tires type		Inflatable
Standard tires		BKT 16.0/70-20 14PR- EM936 SPL
Forks length / width / section	l / e / s	1200 mm x 125 mm x 50 mm
Performances		
Lifting		13 s
Lowering		9 s
Extension		9 s
Retraction		6.10 s
Crowd		4.30 s
Dump		3.20 s
Engine		
Engine brand		Perkins
Engine norm		Stage IIIA
Engine model		1104D-44T
Number of cylinders / Capacity of cylinders		4 - 4400 cm³
Engine power (Hp/kW)		94 Hp / 70 kW
Max. torque / Engine rotation		392 Nm @ 1400 rpm
Drawbar pull		7800 daN
Drawbar pull (Laden)		7800 daN
Transmission		
Transmission type		Torque converter
Number of gears (forward / reverse)		4 / 4
Max. travel speed		28 km/h
Max. travel speed (may vary according to applicable regulations)		28 km/h
Parking brake		Oil-Immersed Multi-Disc Braking front and rear Axle
Service brake		Hydraulic rear & front
Hydraulics		
Hydraulic pump type		Gear pump
Hydraulic flow / Pressure		86.40 l/min-250 bar
Tank capacities		
Engine oil		11.50 l
Hydraulic oil		120 l
Hydraulic tank capacity		15 l
Fuel		78.50 l
Noise and vibration		
Noise at driving position (LpA)		92 dB
Noise to environment (LWA)		110 dB
Vibration on hands/arms		< 2.50 m/s²
Miscellaneous		
Steering wheels (front / rear)		2 / 2
Drive wheels (front / rear)		2 / 2
Cab certification		Cabin ROPS - FOPS level 2
Controls		Monolever

MXT 840 P - Dimensional drawing



MXT 840 P - Load chart

Machine on tires with forks Metric

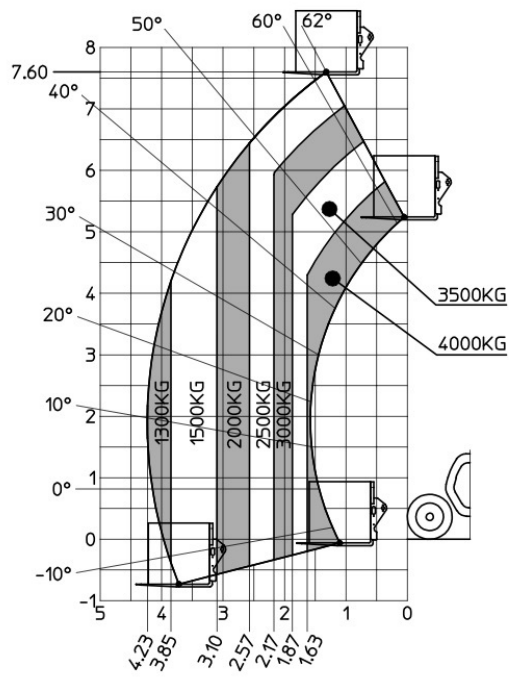

**Head Office**

B.P. 249 - 430 rue de l'Aubinière
44150 Ancenis Cedex - France

Tel: +33 (0)2 40 09 10 11 - Fax: +33 (0)2 40 09 10 97

www.manitou.com



This publication provides a description of the configuration versions and options for Manitou products, which may differ for equipment. The equipment presented in this brochure may be part of a series, as an option, or it may not be available, depending on the versions. Manitou reserves the right, at any time and without notice, to amend the specifications described and represented. The specifications provided do not bind the manufacturer. For more details, please contact your Manitou agent. This is not a contractually binding document. The presentation of the products is not contractually binding. List of specifications non-exhaustive. The logos as well as the visual identity of the company are owned by Manitou and cannot be used without authorisation. All rights reserved. The photos and diagrams contained in this brochure are only provided for consultation and information purposes.

MANITOU BF SA - Limited company with board of directors - Share capital: 39,668,399 euros - 857 802 508 RCS Nantes