

Technical sheet :

# **MLT 420-60 H**

---



 **MANITOU**  
HANDLING YOUR WORLD

Capacities		Metric
Max. capacity	Q	2000 kg
Max. lifting height		4.35 m
Max. outreach		2.65 m
Reach at max. height		1 m
Breakout force with bucket		1886 daN
Weight and dimensions		
Unladen weight (with forks)		4190 kg
Ground clearance	m4	0.26 m
Wheelbase	y	2.13 m
Overall length to carriage (with hitch)	l11	3.64 m
Overall length to carriage (without hitch)	l3	3.64 m
Front overhang		1.04 m
Overall width	b1	1.49 m
Overall cab width	b4	0.80 m
Overall height	h17	1.96 m
Tilt-down angle	a5	116 °
Tilt-up angle	a4	12 °
External turning radius (over tyres)	Wa1	3.06 m
Standard tires		CAMSO - SKS532 - 12-16.5 145A2
Drive wheels (front / rear)		2 / 2
Steering mode		2 wheel steer, 4 wheel steer, Crab mode
Performances		
Lifting		5 s
Lowering		3.50 s
Extension		4.80 s
Retraction		3 s
Crowd		3.30 s
Dump		2.70 s
Engine		
Engine brand		Kubota
Engine nom		Stage V
Engine model		V2607-CR-E5B
Number of cylinders - Capacity of cylinders		4 - 2615 cm³
Engine power (Hp / kW)		57 Hp / 42 kW
Max. torque / Engine rotation		174 Nm @1600 rpm
Drawbar pull (Laden)		2850 daN
Reversible fan		Standard
Engine cooling system		2 radiators water + hydraulic oil
Transmission		
Transmission type		Hydrostatic
Number of gears (forward / reverse)		2 / 2
Max. travel speed (may vary according to applicable regulations)		25 km/h
Differential lock		Limited slip differential on front axle
Parking brake		Automatic negative parking brake
Hydraulics		
Hydraulic pump type		Gear pump
Hydraulic flow - Pressure		77 l/min - 235 bar
Tank capacities		
Hydraulic tank capacity		70 l
Fuel tank capacity		60 l
Noise and vibration		
Noise at driving position (LpA) tested following NF EN 12053 nom		76 dB
Noise to environment (LWA)		104 dB
Vibration on hands/arms		< 2.50 m/s²
Miscellaneous		
Tractor homologation		
Cab certification		ROPS - FOPS cab (level 1)
Controls		JSM

## Optional tires tab

	Overall height	Overall width
ALLIANCE - A550 - 305/70 R16.5 141A5	1.96 m	1.48 m
TRELLEBORG - TH400 - 11LR16 130A8	1.97 m	1.49 m

### MLT 420-60 H - Dimensional drawing



### MLT 420-60 H - Load chart

Machine on tires with forks Metric

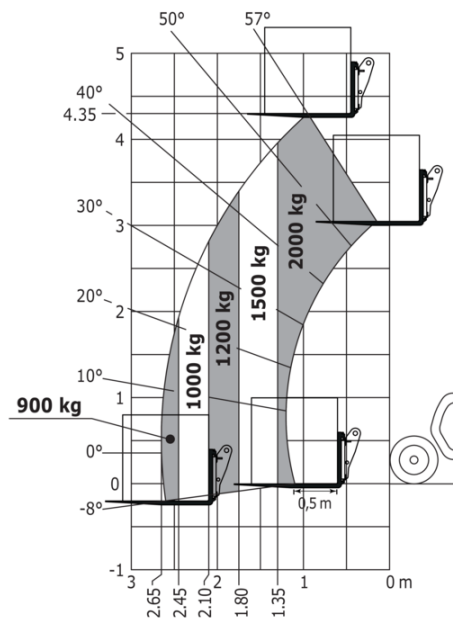

**Head Office**

B.P. 249 - 430 rue de l'Aubinière  
44150 Ancenis Cedex - France

Tel: +33 (0)2 40 09 10 11 - Fax: +33 (0)2 40 09 10 97

[www.manitou.com](http://www.manitou.com)



This publication provides a description of the configuration versions and options for Manitou products, which may differ for equipment. The equipment presented in this brochure may be part of a series, as an option, or it may not be available, depending on the versions. Manitou reserves the right, at any time and without notice, to amend the specifications described and represented. The specifications provided do not bind the manufacturer. For more details, please contact your Manitou agent. This is not a contractually binding document. The presentation of the products is not contractually binding. List of specifications non-exhaustive. The logos as well as the visual identity of the company are owned by Manitou and cannot be used without authorisation. All rights reserved. The photos and diagrams contained in this brochure are only provided for consultation and information purposes.

MANITOU BF SA - Limited company with board of directors - Share capital: 39,668,399 euros - 857 802 508 RCS Nantes