

Technical sheet :

# **MLT-X 1041-145 PS+L**

---



 **MANITOU**  
HANDLING YOUR WORLD

| Capacities  |     | Metric   |
|---|-----|--|
| Max. capacity   | Q   | 4100 kg  |
| Max. lifting height   |     | 9.65 m   |
| Max. outreach   |     | 6.50 m   |
| Reach at max. height  |     | 1.50 m   |
| Breakout force with bucket  |     | 5043 daN   |
| Weight and dimensions   |     |  |
| Unladen weight (with forks)                                       |     | 9690 kg  |
| Ground clearance  | m4  | 0.43 m   |
| Wheelbase   | y   | 2.88 m   |
| Overall length to carriage (with hitch)                           | l11 | 5.20 m   |
| Overall length to carriage (without hitch)                        | l3  | 5.03 m   |
| Front overhang  |     | 1.30 m   |
| Overall width   | b1  | 2.39 m   |
| Overall cab width   | b4  | 0.99 m   |
| Overall height  | h17 | 2.42 m   |
| Tilt-down angle   | a5  | 135 °  |
| Tilt-up angle   | a4  | 12 °   |
| External turning radius (over tyres)                              | Wa1 | 3.74 m   |
| Standard tires  |     | Michelin - XMCL - 460/70 R24 159A8                                   |
| Drive wheels (front / rear)                                       |     | 2 / 2  |
| Steering mode   |     | Manicrab, 2 wheel steer, 4 wheel steer, Crab mode                    |
| Frame leveling corrector  | a9  | 7 °  |
| Performances  |     |  |
| Lifting   |     | 6.60 s   |
| Lowering  |     | 4.70 s   |
| Extension   |     | 9.50 s   |
| Retraction  |     | 6.90 s   |
| Crowd   |     | 3.70 s   |
| Dump  |     | 2.80 s   |
| Engine  |     |  |
| Engine brand  |     | Yanmar   |
| Engine norm   |     | Stage IIIA   |
| Max. fuel sulphur content   |     | 1000 ppm   |
| Engine model  |     | 4TN107HT-5SMUF   |
| Number of cylinders - Capacity of cylinders                       |     | 4 - 4567 cm <sup>3</sup>   |
| Engine power (Hp / kW)  |     | 141 Hp / 105 kW  |
| Max. torque / Engine rotation                                     |     | 602 Nm @1500 rpm   |
| Drawbar pull (Laden)  |     | 9130 daN   |
| Reversible fan  |     | Standard   |
| Engine cooling system   |     | 4 radiators (water + intercooler + hydraulic oil + transmission oil) |
| Transmission  |     |  |
| Transmission type   |     | Torque converter with powershift gearbox                             |
| Gearbox   |     | M-Shift  |
| Number of gears (forward / reverse)                               |     | 5 / 3  |
| Max. travel speed (may vary according to applicable regulations)  |     | 40 km/h  |
| Differential lock   |     | Limited slip differential on front and rear axles                    |
| Parking brake   |     | Automatic negative parking brake                                     |
| Service brake   |     | Oil-immersed multi-discs braking on front & rear axles               |
| Hydraulics  |     |  |
| Hydraulic pump type   |     | Variable displacement pump   |
| Hydraulic flow - Pressure   |     | 200 l/min - 270 bar  |
| Flow sharing distributor  |     | Standard   |
| Tank capacities   |     |  |
| Hydraulic tank capacity   |     | 141 l  |
| Fuel tank capacity  |     | 142 l  |
| Noise and vibration   |     |  |
| Noise at driving position (LpA) tested following NF EN 12053 norm |     | 69 dB  |
| Noise to environment (LwA)  |     | 105 dB   |
| Vibration on hands/arms   |     | < 2.50 m/s <sup>2</sup>  |
| Miscellaneous   |     |  |
| Tractor homologation  |     | Tractor homologation   |
| Cab certification   |     | Cabin ROPS - FOPS level 2  |
| Controls  |     | JSM  |

## Optional tires tab

|  | Overall height | Overall width |
|--|----------------|---------------|
| ALLIANCE - A580 - 460/70 R24 159A8       | -              | -             |
| ALLIANCE - A585 - 460/70 R24 159A8       | -              | -             |
| MICHELIN - BIBLOAD - 460/70 R24 159A8    | -              | -             |
| MICHELIN - BIBLOAD - 500/70 R24 164A8    | -              | -             |
| MICHELIN - XMCL - 500/70 R24 164A8       | -              | -             |
| TRELLEBORG - TH400 - 460/70 R24 159A8    | -              | -             |
| TRELLEBORG - TH400 - 500/70 R24 164A8    | -              | -             |
| TRELLEBORG - TH500 - 460/70 R24 159A8    | -              | -             |
| VREDESTEIN - ENDURION - 460/70 R24 159A8 | -              | -             |
| VREDESTEIN - ENDURION - 500/70 R24 164A8 | -              | -             |

## MLT-X 1041-145 PS+L - Dimensional drawing



## MLT-X 1041-145 PS+L - Load chart

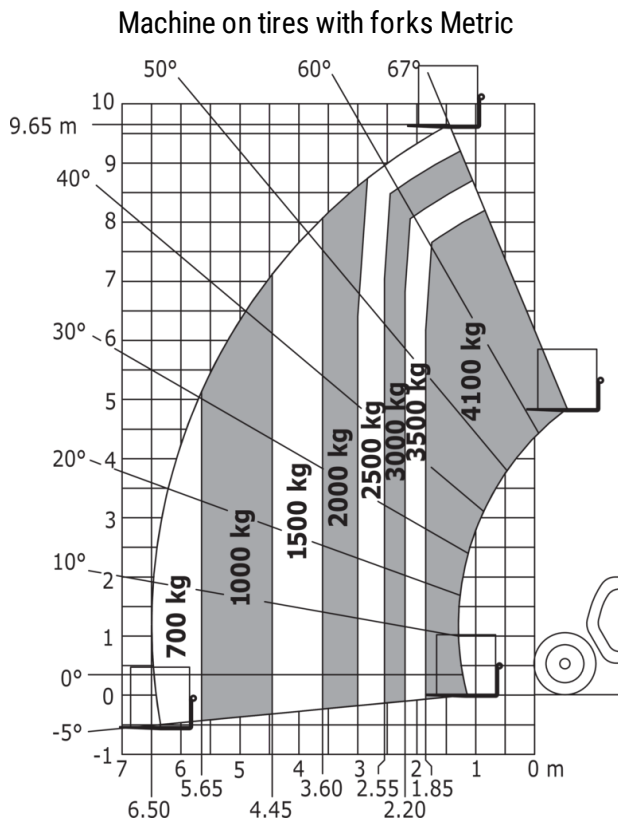



**Head Office**

B.P. 249 - 430 rue de l'Aubinière  
44150 Ancenis Cedex - France

Tel: +33 (0)2 40 09 10 11 - Fax: +33 (0)2 40 09 10 97

[www.manitou.com](http://www.manitou.com)



This publication provides a description of the configuration versions and options for Manitou products, which may differ for equipment. The equipment presented in this brochure may be part of a series, as an option, or it may not be available, depending on the versions. Manitou reserves the right, at any time and without notice, to amend the specifications described and represented. The specifications provided do not bind the manufacturer. For more details, please contact your Manitou agent. This is not a contractually binding document. The presentation of the products is not contractually binding. List of specifications non-exhaustive. The logos as well as the visual identity of the company are owned by Manitou and cannot be used without authorisation. All rights reserved. The photos and diagrams contained in this brochure are only provided for consultation and information purposes.

MANITOU BF SA - Limited company with board of directors - Share capital: 39,668,399 euros - 857 802 508 RCS Nantes