

Fiche technique :

MLT-X 1041-145 PS+L



 **MANITOU**
HANDLING YOUR WORLD

Capacités		Métrique
Capacité max.	Q	4100 kg
Hauteur de levage max.		9.65 m
Déport maximal		6.50 m
Déport à hauteur max.		1.50 m
Effort d'arrachement au godet		5043 daN
Poids et dimensions		
Poids à vide (avec fourches)		9690 kg
Garde au sol	m4	0.43 m
Empattement	y	2.88 m
Longueur hors tout au tablier (avec crochet d'attelage)	l11	5.20 m
Longueur hors tout au tablier (sans crochet d'attelage)	l3	5.03 m
Porte-à-faux avant		1.30 m
Largeur hors tout	b1	2.39 m
Largeur hors tout cabine	b4	0.99 m
Hauteur hors tout	h17	2.42 m
Angle de déversement	a5	135 °
Angle de cavage	a4	12 °
Rayon de braquage (extérieur roues)	Wa1	3.74 m
Pneus standards		Michelin - XMCL - 460/70 R24 159A8
Roues motrices (avant / arrière)		2 / 2
Mode de direction		Manicrab, 2 roues directrices, 4 roues directrices, Mode crabe
Correcteur de dévers	a9	7 °
Performances		
Levage		6.60 s
Descente		4.70 s
Sortie de télescope		9.50 s
Rentrée de télescope		6.90 s
Cavage		3.70 s
Déversement		2.80 s
Moteur		
Marque du moteur		Yanmar
Norme moteur		Stage IIIA
Teneur en soufre max. du carburant		1000 ppm
Modèle du moteur		4TN107HT-5SMUF
Nombre de cylindres - Cylindrée		4 - 4567 cm ³
Puissance moteur (CV / kW)		141 ch / 105 kW
Couple max. / Régime moteur		602 Nm @1500 tr/min
Effort de traction en charge		9130 daN
Système de décolmatage automatique des radiateurs		Standard
Système de refroidissement		4 radiateurs (eau + air + huile hydraulique + huile transmission)
Transmission		
Type de transmission		Convertisseur de couple avec boîte de vitesses powershift
Boîte de vitesses		M-Shift
Nombre de vitesses (avant / arrière)		5 / 3
Vitesse max. de déplacement (peut varier selon la réglementation applicable)		40 km/h
Blocage de différentiel		Différentiel à glissement limité sur les essieux avant et arrière
Frein de parking		Frein de stationnement négatif automatique
Frein de service		Freinage multidisques à bain d'huile sur pont avant et arrière
Hydraulique		
Type de pompe hydraulique		Pompe à débit variable
Débit hydraulique - Pression hydraulique		200 l/min - 270 bar
Distributeur "flow sharing"		Standard
Capacités des réservoirs		
Capacité du réservoir hydraulique		141 l
Carburant		142 l
Bruit et vibration		
Bruit au poste de conduite (LpA) testé selon la norme NF EN 12053		69 dB
Bruit à l'environnement (LwA)		105 dB
Vibration sur l'ensemble mains/bras		< 2.50 m/s ²
Divers		
Homologation tracteur		Homologation tracteur
Certification cabine		Cabine ROPS - FOPS niveau 2
Commandes		JSM

Tableau des pneus optionnels

	Hauteur hors tout	Largeur hors tout
ALLIANCE - A580 - 460/70 R24 159A8	-	-
ALLIANCE - A585 - 460/70 R24 159A8	-	-
MICHELIN - BIBLOAD - 460/70 R24 159A8	-	-
MICHELIN - BIBLOAD - 500/70 R24 164A8	-	-
MICHELIN - XMCL - 500/70 R24 164A8	-	-
TRELLEBORG - TH400 - 460/70 R24 159A8	-	-
TRELLEBORG - TH400 - 500/70 R24 164A8	-	-
TRELLEBORG - TH500 - 460/70 R24 159A8	-	-
VREDESTEIN - ENDURION - 460/70 R24 159A8	-	-
VREDESTEIN - ENDURION - 500/70 R24 164A8	-	-

MLT-X 1041-145 PS+L - Schémas d'encombrement

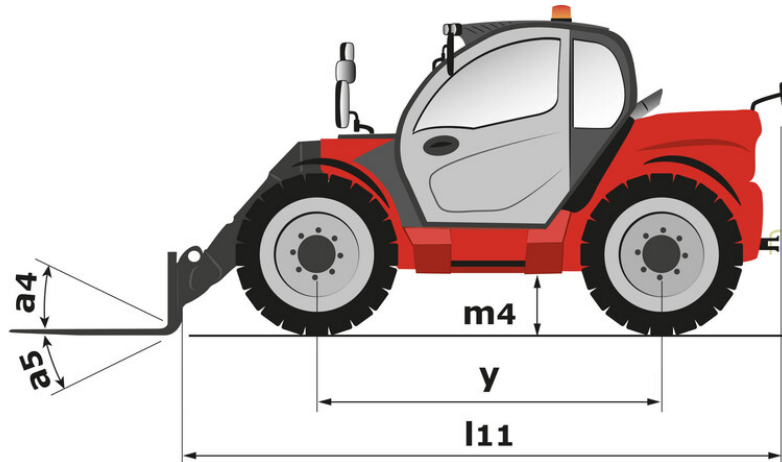

MLT-X 1041-145 PS+L - Abaques

Machine sur pneus avec fourches





Siège Social

B.P. 249 - 430 rue de l'Aubinière
44150 Ancenis Cedex - France

Tel: +33 (0)2 40 09 10 11 - Fax: +33 (0)2 40 09 10 97

www.manitou.com



Cette publication présente le descriptif des versions et possibilités de configuration des produits Manitou qui peuvent différer en équipement. Les équipements présentés dans cette brochure peuvent être de série, en option, ou non disponibles suivant les versions. Manitou se réserve le droit, à tout moment et sans préavis, de modifier les spécifications décrites et représentées. Les spécifications portées n'engagent pas le constructeur. Pour plus de détails, contactez votre concessionnaire Manitou. Document non contractuel. Présentation des produits non contractuelle. Liste des spécifications non exhaustive. Les logos ainsi que l'identité visuelle de l'entreprise sont la propriété de Manitou et ne peuvent être utilisés sans autorisation. Tous droits réservés. Les photos et schémas contenus dans la présente brochure ne sont fournis qu'à des fins de consultation et à titre indicatif.

Manitou BF SA - Société anonyme à conseil d'administration - Capital social : 39 668 399 euros - 857 802 508 RCS Nantes