

Ficha técnica :

MLT-X 961-160 V+ L



 **MANITOU**
HANDLING YOUR WORLD

Capacidad		Métrico
Capacidad de elevación máx.	Q	6000 kg
Altura de elevación máx		9 m
Alcance máx		5.30 m
Alcance a altura máxima		1.10 m
Fuerza de arranque con cuchara		7300 daN
Peso y dimensión		
Peso sin carga (con horquillas)		11950 kg
Distancia al suelo	m4	0.45 m
Distancia entre ejes	y	3 m
Longitud total hasta el carro (con enganche)	l11	6.10 m
Overall length to carriage (without hitch)	l3	5.97 m
Voladizo delantero		1.65 m
Anchura total	b1	2.48 m
Anchura total de la cabina	b4	0.99 m
Altura total	h17	2.55 m
Ángulo de vertido	a5	135 °
Ángulo de volteo	a4	12 °
Radio de giro exterior	Wa1	4.30 m
Modelos de los neumáticos		Alliance - A580 - 500/70 R24 164A8
Ruedas motrices (delanteras / traseras)		2 / 2
Modo de dirección		Manicrab, Dirección de 2 ruedas, Dirección de 4 ruedas, Modo oblicuo
Corrector de nivel	a9	7 °
Rendimiento		
Subida		8.50 s
Bajada		6.50 s
Salida del telescopio		7 s
Retracción		6 s
Cavado		3.80 s
Vertido		3.60 s
Motor		
Marca		Yanmar
Norma del motor		Fase IIIA
Contenido máximo de azufre del combustible		1000 ppm
Modelo de motor		4TN107TT-5SMUF
Nº de cilindros - Capacidad de cilindros		4 - 4567 cm³
Potencia del motor (CV / kW)		156 Hp / 115 kW
Par máx. / Rotación del par de motor		805 Nm @1350 rpm
Esfuerzo de tracción		9700 daN
Sistema de limpieza automático de radiadores		estándar
Sistema de refrigeración del motor		3 radiadores (agua + refrigeración interna + aceite transmisión)
Transmisión		
Tipo de transmisión		M-Vario Plus
Velocidad de desplazamiento máx. (km/h) (puede variar según la normativa aplicable)		40 km/h
Freno de aparcamiento		Freno de estacionamiento negativo automático
Freno de servicio		Frenos en baño de aceite multidisco en el eje delantero y trasero
Hidráulico		
Tipo de bomba		Bomba Load sensing
Caudal hidráulico - Presión hidráulica		200 l/min - 270 bar
Distribuidor "flow sharing"		estándar
Capacidad del tanque		
Capacidad del depósito hidráulico		180 l
Carburante		142 l
Ruido y vibración		
Ruido en el puesto de conducción (LpA) verificado según la norma NF EN 12053		69 dB
Ruido en el entorno (LwA)		105 dB
Vibraciones en manos/brazos		< 2.50 m/s²
Varios		
Homologación seguridad tractor		Homologación seguridad tractor
Certificación de cabina		Cabina ROPS - FOPS nivel 2
Mandos		JSM

mesa de neumáticos opcional

	Altura total	Anchura total
ALLIANCE - A580 - 500/70 R24	-	-
ALLIANCE - EM L-3/E3 - 17.5 R25	-	-
MICHELIN - BIBLOAD - 500/70 R24 164A8	-	-
MICHELIN - XHA - 17.5 R25	-	-
MICHELIN - XMCL - 500/70 R24 164A8	-	-
MITAS - EM60 - 17.5 R25	-	-
NOKIAN - TRI STEEL - 500/70 R24 164A8	-	-
SOLIDEAL - SOLIDAIR TLH - 14.00 R24	-	-
TRELLEBORG - TH400 - 500/70 R24 164A8	-	-
VREDESTEIN - ENDURION - 500/70 R24 164A8	-	-

MLT-X 961-160 V+ L - Diagrama dimensional

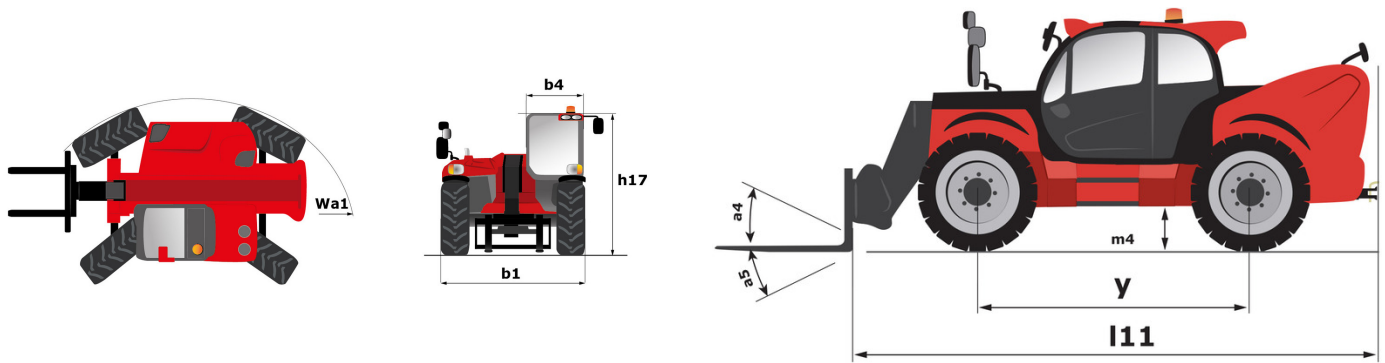

MLT-X 961-160 V+ L - Diagramas de carga

Máquina sobre neumáticos con horquillas

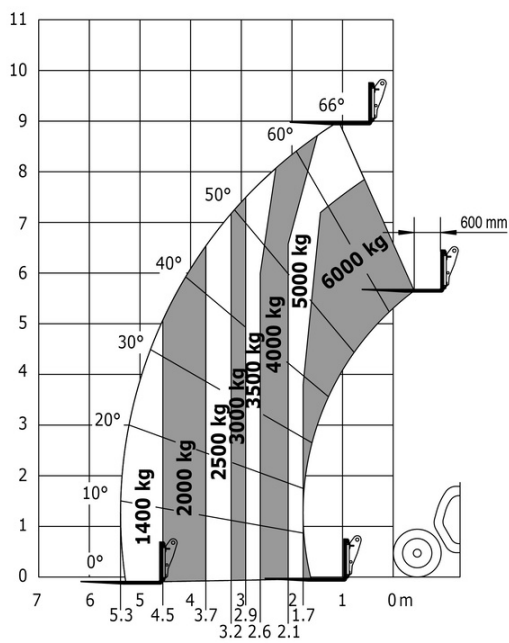

Máquina sobre neumáticos con horquillas LC 600 mm

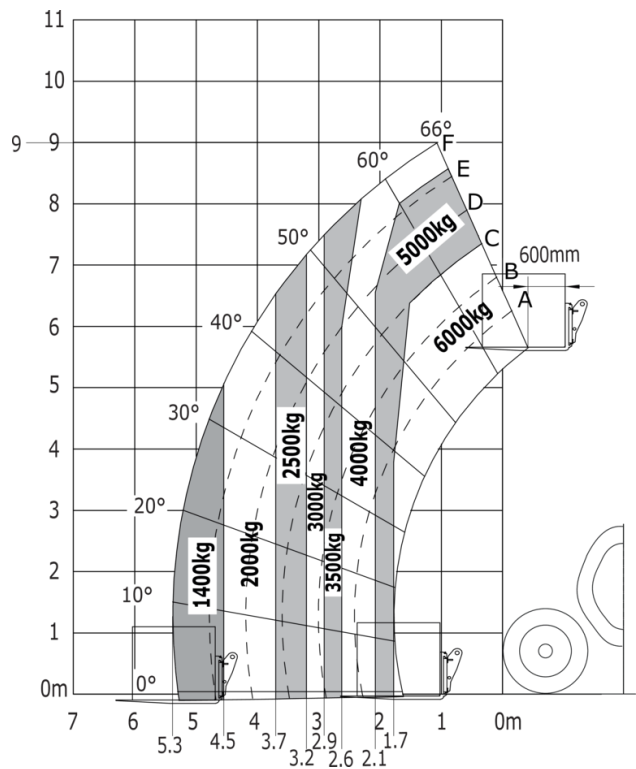



Oficina Central

B.P. 249 - 430 rue de l'Aubinière

44150 Ancenis Cedex - Francia

Tel.: 00 33 (0)2 40 09 10 11 - Fax: 00 33 (0)2 40 09 10 97

www.manitou.com



Esta publicación describe las versiones y posibilidades de configuración de los productos Manitou que puedan diferir en equipamiento. Los equipamientos presentados en este folleto pueden ser de serie, opcionales o no estar disponibles en algunas versiones. Manitou se reserva el derecho, en cualquier momento y sin previo aviso, de modificar las especificaciones descritas y representadas. Las especificaciones aportadas no comprometen al fabricante. Para más información, póngase en contacto con su concesionario Manitou. Documento no contractual. Presentación de los productos no contractual. Lista de especificaciones no exhaustiva. Los logos y la identidad visual de la empresa son propiedad de Manitou y no pueden ser utilizados sin autorización. Todos los derechos reservados. Las fotos y los esquemas contenidos en este folleto se ofrecen para consulta y a título indicativo solamente.

Manitou BF SA - Sociedad anónima con Consejo de Administración - Capital social: 39 668 399 euros - 857 802 508 RCS Nantes