

Technisches Datenblatt :

MRT 1645 75

VISION



 **MANITOU**
HANDLING YOUR WORLD

Kapazität		Metrisch
Max. Tragkraft	Q	4500 kg
Max. Hubhöhe		15.80 m
Max. Reichweite		13.50 m
Gewicht und Reifengröße		
Gesamtlänge mit Gabeln	l1	7.58 m
Länge bis zur Vorderseite der Gabeln	l2	6.38 m
Gesamtbreite	b1	2.42 m
Gesamthöhe	h17	3.04 m
Gesamtbreite der Kabine	b4	0.96 m
Wenderadius (über Räder)	Wa1	3.92 m
Bodenfreiheit	m4	0.37 m
Radstand	y	2.43 m
Aufwärtsneigewinkel	a4	12 °
Abwärtsneigewinkel	a5	105 °
Drehung des Oberwagens		400 °
Gewicht		13305 kg
Gabeln Länge / Gabeln Breite / Gabelquerschnitt	l / e / s	1200 mm x 125 mm x 50 mm
Reifen		
Reifenmodelle		405/70-20
Antriebsräder (vorne / hinten)		2 / 2
Lenkart		2-rad Lenkung, 4-rad Lenkung, Krebsgang
Stützen		
Typ Abstützung		Flügeltyp
Steuerung mit Stützen		Stützenbefehle einzeln oder gleichzeitig
Motor		
Hersteller		Deutz
Motomom		Stage V, Tier 4
Motormodell		TCD 3.6 L4
Motorleistung (PS / kW)		75 Hp / 55.40 kW
Max. Drehmoment / Motordrehzahl (min)		405 Nm @ 1300 rpm
Zylinderzahl - Tragfähigkeit der Zylinder		4 - 3620 cm³
Motor Kühlsystem (wassergekühlt)		Wasserkühlung
Elektrischer Schaltkreis		
Anzahl Batterien / Batterie		2 x 12 V
12V Batteriekapazität		120 Ah
Anlaufstrom der Batterien		(EN) 850 A
Getriebe		
Getriebetyp		Hydrostatisch
Anzahl der Gänge (vorwärts / rückwärts)		2 / 2
Max. Fahrgeschwindigkeit		25 km/h
Zugkraft		9400 daN
Parkbremse		Automatische negative Parkbremse
Feststellbremse		Ölbad Lamellenbremsen an den Vorder- und Hinterachsen
Leistung		
Steigfähigkeit - beladen / unbeladen		44.50 % / 44.50 %
Hydraulisch		
Typ Hydraulikpumpe		Verstellpumpe
Hydraulikfördermenge		116 l/min
Hydraulikfördermenge - Hydraulikdruck		275 bar
Tankkapazität		
Motoröl		11 l
Kraftstoff		130 l
Lärm und Vibrationen		
Geräuschpegel im Fahrerstand (LpA)		68 dB
Umgebungsgeräusch (LwA)		104 dB
Schwingungsbelastung Hand/Arm		< 2.50 m/s²
Sonstiges		
Lenkräder (vorne / hinten)		2 / 2
Steuerungen		2 Joysticks
Kabinen-Zertifizierung		Kabine ROPS - FOPS Stufe 2
Anbaugeräte Erkennungssystem (E-Reco)		Standard

MRT 1645 75 - Maßzeichnung



Sonstige Daten		Metrisch
Länge des Rahmens	l14	4.67 m
Gegengewicht Versatz (Oberwagen bei 90°)	a7	2.50 m
Gesamtlänge mit Stabilisatoren	l12	4.41 m
Gesamtbreite, Stabilisatoren ausgefahren	b7	4.01 m
Bodenfreiheit unter den Vorderreifen auf Stützen	m5	0.18 m

MRT 1645 75 - Traglasttabellen

Maschine auf Rädern mit Gabelzinken



Drehung mit abgesenkten Stützen mit Gabeln



Drehung mit abgesenkten Stützen mit Seilwinde 5000 kg Maschine auf abgesenkten Stabilisatoren mit 4000 kg Galgen (Metrisch)

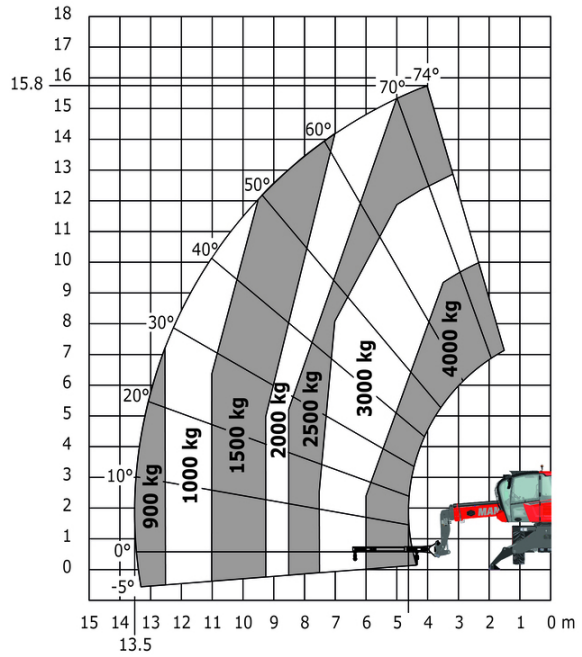

Maschine auf abgesenkten Stabilisatoren mit 1500 kg Winde Maschine auf abgesenkten Stabilisatoren mit Haken 5000 kg (Metrisch)

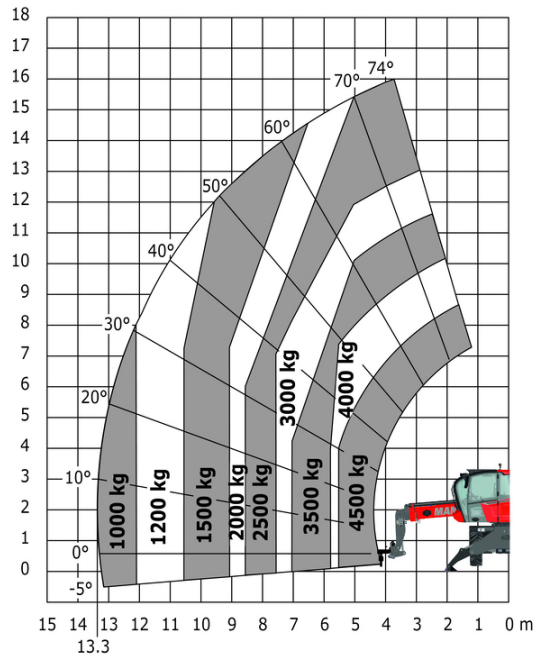
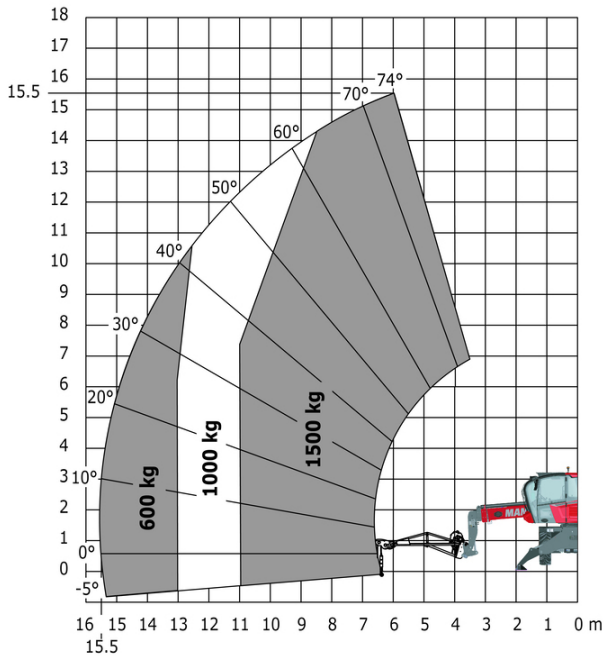

Drehung an abgesenkten Stützen mit 365 kg Arbeitskorb

Drehung an abgesenkten Stützen mit 1000 kg Arbeitskorb



**Hauptsitz**

B.P. 249 - 430 rue de l'Aubinière
44150 Ancenis Cedex - France

Tel: +33 (0)2 40 09 10 11 - Fax: +33 (0)2 40 09 10 97

www.manitou.com



Diese Publikation enthält eine Beschreibung der Konfigurationsvarianten und Optionen für Manitou-Produkte, die je nach Ausstattung unterschiedlich sein können. Die in dieser Broschüre vorgestellten Ausstattungen können Teil einer Serie, als Option erhältlich oder je nach Ausführung nicht verfügbar sein. Manitou behält sich das Recht vor, die beschriebenen und dargestellten Spezifikationen jederzeit und ohne Vorankündigung zu ändern. Die angegebenen Spezifikationen sind für den Hersteller nicht bindend. Für weitere Einzelheiten wenden Sie sich bitte an Ihren Manitou-Händler. Es handelt sich nicht um ein vertraglich bindendes Dokument. Die Darstellung der Produkte ist vertraglich nicht bindend. Die Liste der Spezifikationen ist nicht vollständig. Die Logos sowie die visuelle Identität des Unternehmens sind Eigentum von Manitou und dürfen nicht ohne Genehmigung verwendet werden. Alle Rechte vorbehalten. Die in dieser Broschüre enthaltenen Fotos und Diagramme werden nur zu Anschauungs- und Informationszwecken zur Verfügung gestellt.

MANITOU BF SA - Gesellschaft mit beschränkter Haftung mit Verwaltungsrat - Aktienkapital: 39 668 399 Euro - 857 802 508 RCS Nantes