

Scheda tecnica :

MRT 1845 75

VISION



 **MANITOU**
HANDLING YOUR WORLD

Capacities		Metri
Max. capacity		4500 kg
Max. lifting height		18 m
Max. outreach		15.20 m
Weight and dimensions		
Overall length (with forks)	l1	7.26 m
Length to face of forks	l2	6.06 m
Overall width	b1	2.42 m
Overall height	h17	3.04 m
Overall cab width	b4	0.96 m
Ground clearance	m4	0.37 m
Wheelbase	y	2.43 m
Tilt-up angle	a4	10 °
Tilt-down angle	a5	107 °
Turret rotation / rotation (Max.)		400 ° or 360 °
Overall weight		14100 kg
Forks length / width / section	l / e / s	1200 mm x 125 mm x 50 mm
Wheels		
Standard tires		405/70-20
Drive wheels (front / rear)		2 / 2
Steering mode		2 wheel steer, 4 wheel steer, Crab mode
Stabilisers		
Stabilizers Type		Wing Type
Controls with stabs		Stabs Commands Individual or Simultaneous
Engine		
Engine brand		Deutz
Engine nom		Stage V / Tier 4
Engine model		TCD 3.6 L4
I.C. Engine power rating / Power		75 Hp / 55.40 kW
Max. torque / Engine rotation (min)		405 Nm @ 1300 rpm
Number of cylinders - Capacity of cylinders		4 - 3620 cm³
Engine cooling system		Water cooled
Electric circuit		
Number of batteries / Battery voltage		2 x 12 V
12V Battery capacity		120 Ah
Battery starting current		(EN)850 A
Transmission		
Transmission type		Hydrostatic
Number of gears (forward / reverse)		2 / 2
Max. travel speed		25 km/h
Drawbar pull		9400 daN
Parking brake		Automatic negative parking brake
Service brake		Oil-immersed multi-discs braking on front & rear axles
Performances		
Gradeability (laden / unladen)		44.50 % / 44.50 %
Hydraulics		
Hydraulic pump type		Variable displacement pump
Hydraulic flow		116 l/min
Hydraulic Pressure		275 bar
Tank capacities		
Engine oil		11 l
Fuel tank		130 l
Noise and vibration		
Noise at driving position (LpA)		68 dB
Noise to environment (LWA)		104 dB
Vibration on hands/arms		< 2.50 m/s²
Miscellaneous		
Steering wheels (front / rear)		2 / 2
Controls		2 Joysticks
Safety cab homologation		Cabin ROPS - FOPS level 2
Attachment recognition system (E-Reco)		Standard

MRT 1845 75 - Disegno quotato

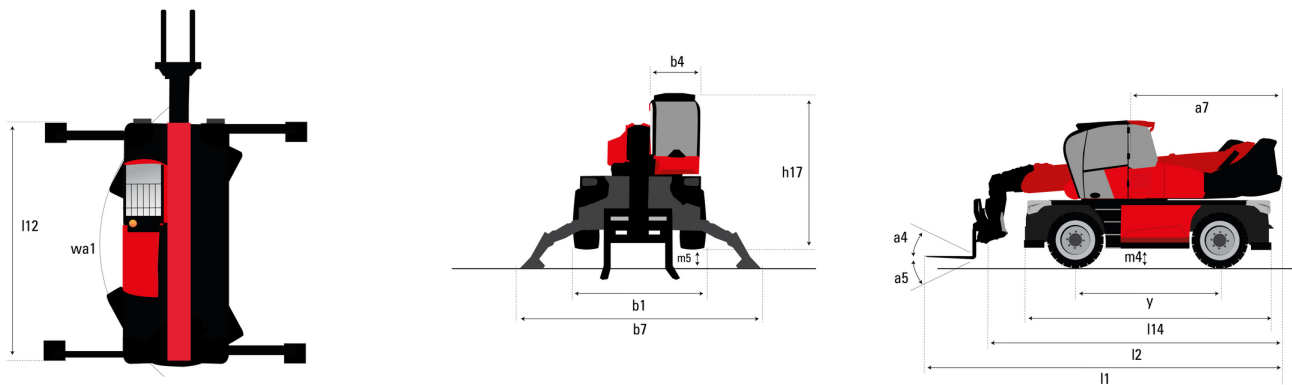

Altri dati		Metrico
Length of frame	$l14$	4.67 m
Wheelbase	y	2.43 m
Ground clearance	$m4$	0.37 m
Counterweight offset (turret at 90°)	$a7$	2.50 m
Tilt-up angle	$a4$	10°
Tilt-down angle	$a5$	107°
Overall length at stabilisers	$l12$	4.41 m
External turning radius (over tyres)	$Wa1$	3.92 m
Overall width with stabilisers extended	$b7$	4.01 m
Overall height	$h17$	3.04 m
Ground clearance under front tires on stabilizers	$m5$	0.18 m

MRT 1845 75 - Diagramma di carico

Machine on tires with forks Metric

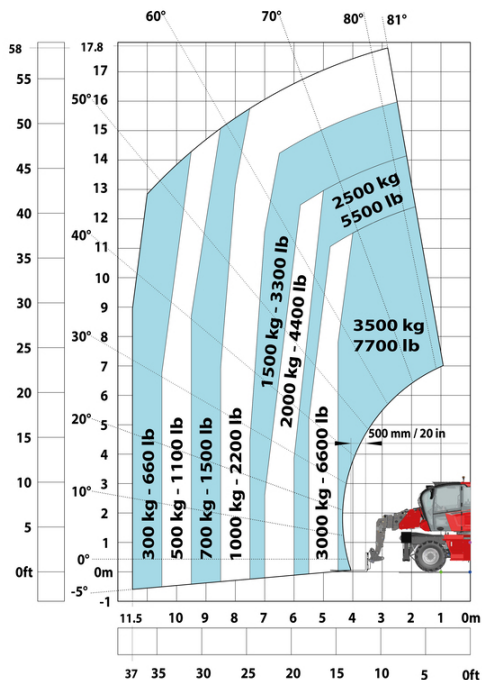

Machine on lowered stabilisers with forks Metric

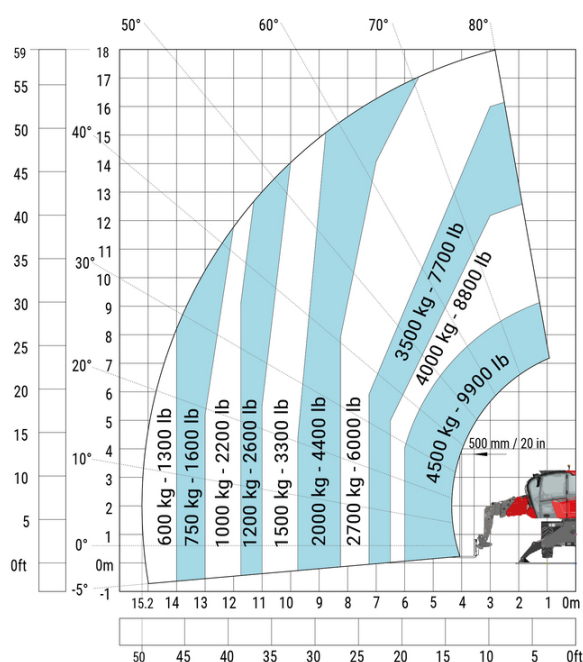

Machine on lowered stabilisers with winch 5000 kg Metric

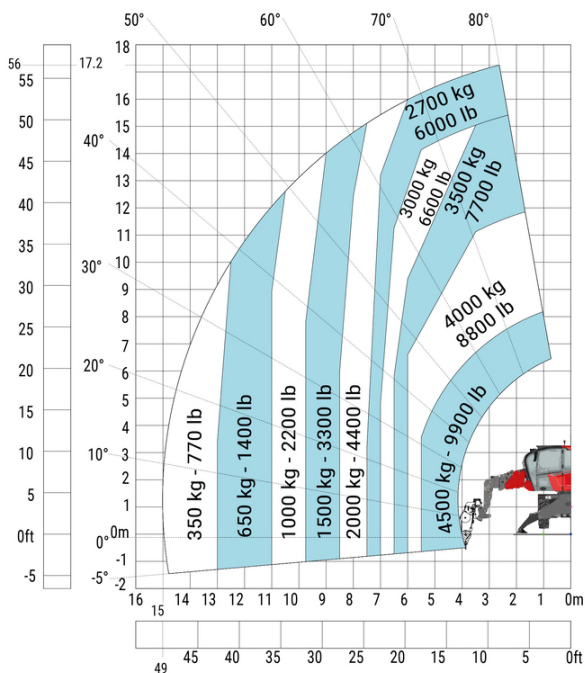

Machine on lowered stabilisers with 1500 kg jib Metric

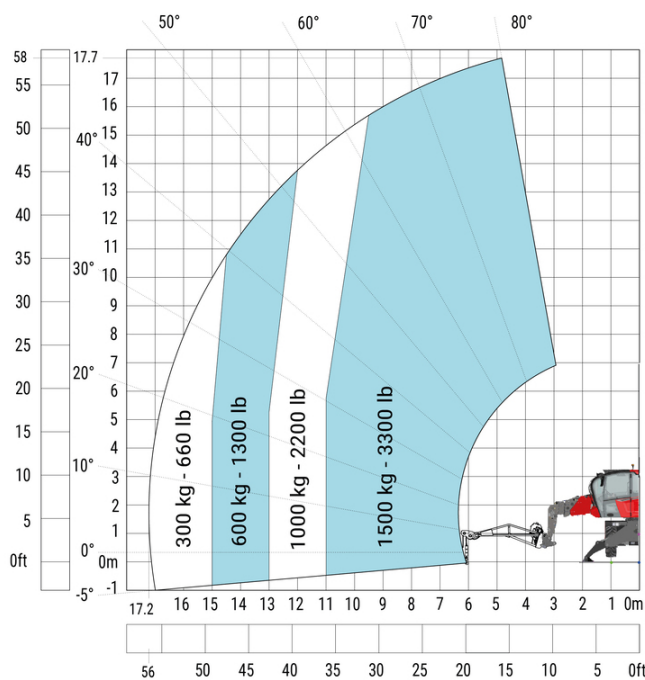

Machine on lowered stabilisers with 4000 kg jib (Metric)

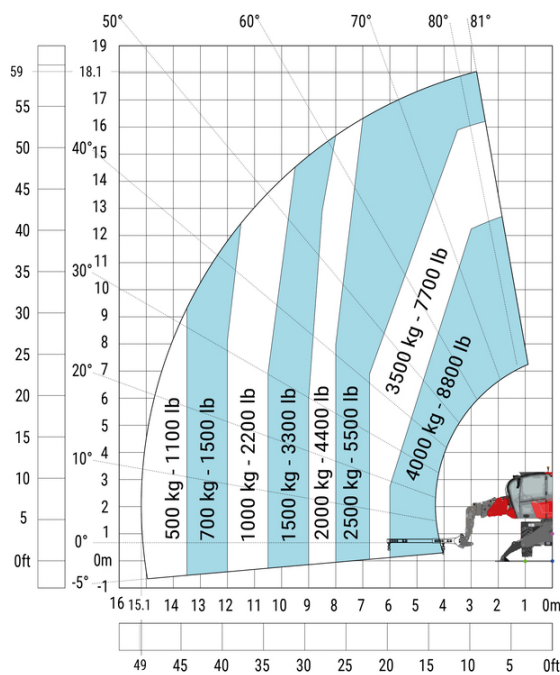

Machine on lowered stabilisers with 1500 kg jib with winch (Metric)

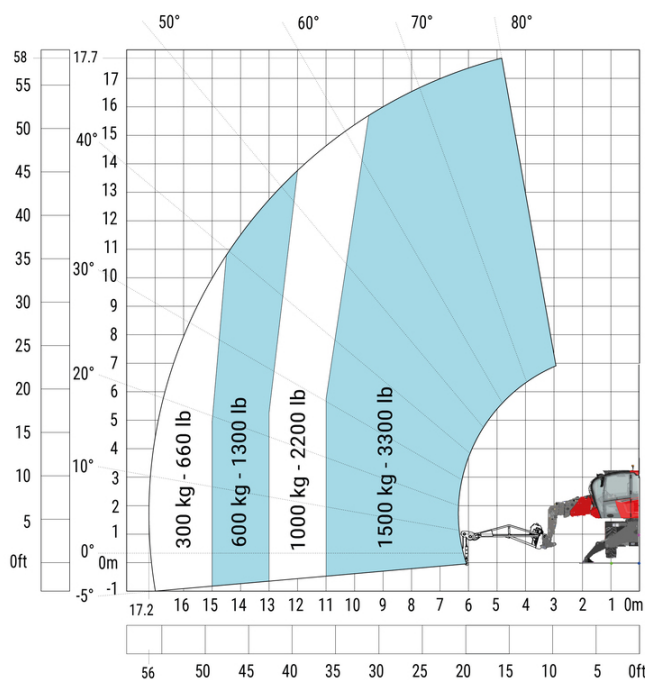

Machine on lowered stabilisers with hook 5000 kg (Metric) Machine on lowered stabilisers with 365 kg platform Metric

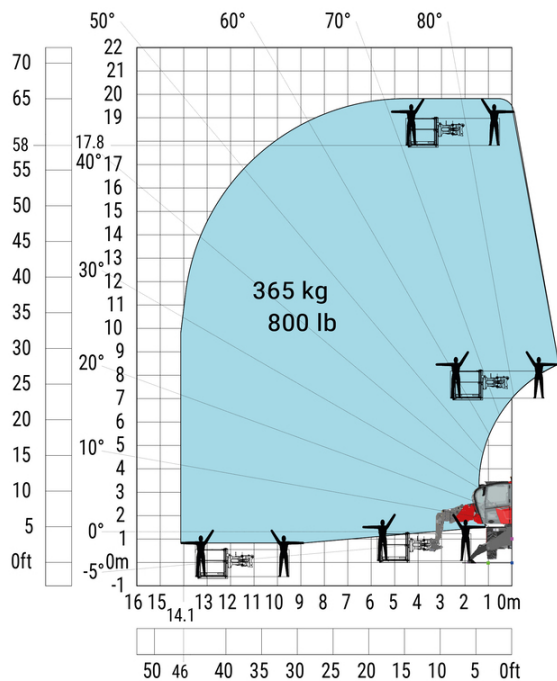
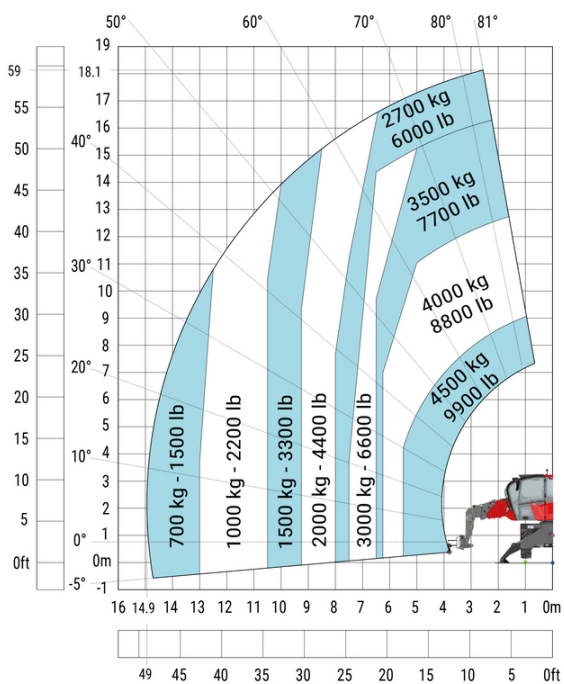

Machine on lowered stabilisers with 1000 kg platform Metric

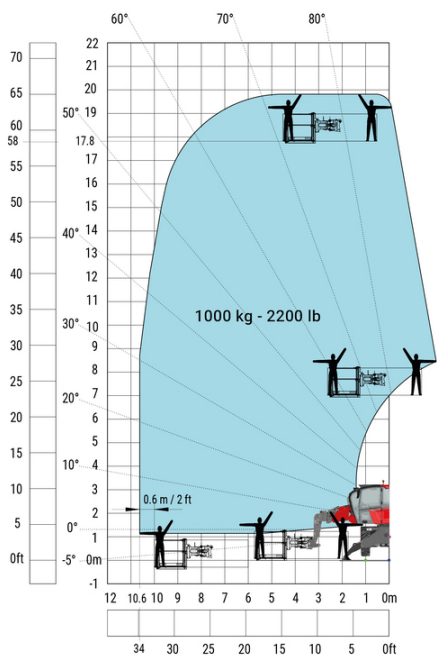



MANITOU **HANDLING YOUR WORLD**

Sede centrale

MANITOU ITALIA Srl

Via Cristoforo Colombo 2, Loc. Cavazzona - 41013 CASTELFRANCO EMILIA (MO)

Tel: 059.95.98.11 - Fax 059.95.98.65

www.manitou.com



Questa pubblicazione presenta la descrizione delle versioni e delle possibilità di configurazione dei prodotti Manitou, che possono differire per attrezzature. Gli allestimenti presentati nel presente opuscolo possono essere di serie, optional o non disponibili, a seconda delle versioni. Manitou si riserva il diritto di modificare, in qualsiasi momento e senza alcun preavviso, le specifiche tecniche descritte e rappresentate. Le specifiche indicate non rappresentano alcun obbligo per il costruttore. Per maggiori dettagli, rivolgersi al proprio concessionario Manitou. Documento non contrattuale. Elenco delle specifiche non esaustivo. I loghi nonché l'identità visiva dell'azienda sono di proprietà di Manitou e non possono essere utilizzati senza autorizzazione. Tutti i diritti riservati. Le immagini e gli schemi contenuti nel presente opuscolo sono forniti esclusivamente a fini di consultazione e a titolo indicativo.

Manitou BF SA - Società anonima con consiglio di amministrazione. Capitale sociale: 39,668,399 euro - 857 802 508 RCS Nantes